

Name: _____
 Invoice: _____ Date: _____ Phone: _____
 Address: _____
 Shop: _____ Phone: _____

REGISTRATION DATA

Warning: Continuous expose to sound pressure levels over 85dB may cause permanent hearing loss.

After the warranty expires, Banda Audioparts will continue to provide extensive technical assistance directly or through its network of authorized service, charging, however, the repair services and replacement of components

Note: Permanent Technical Support

Banda Audioparts reserves the right to change the product and its specifications at any time without prior notice.

Rua Hum, 188 - Jardim Santa Teresinha II - Paulínia - SP - Brazil - CEP: 13148-133

The defective equipment must be shipped to the factory or to an authorized service center

This warranty does not cover shipping costs.

1. Damage resulting from misuse, abuse, accident, alterations or improper installation;
2. Damage resulting from installation in surfaces subjected to high levels of vibration;
3. Corrective work necessitated by repairs made by anyone other than a Banda Audioparts authorized service technician.

Warranty Exclusions:

Within the period of this warranty, Banda Audioparts will repair or replace, free of charge, any part proving defective in material or workmanship.
 Banda Audioparts warrants this equipment to be free of all defects in material and workmanship for a period of 12 months from the date of purchase

WARRANTY

www.bandaaudioaparts.com

Made in Brazil 

VIKING 10.000

BANDA
AUDIOPARTS

USER MANUAL

INDEX

- 02 Technical Specification
- 03 Front Panel
- 04 Power Supply, Signal Input and Power Output Sections
- 04 Clip Indicator
- 04 Subsonic and Crossover Controls
- 05 Connection Example
- 06 Connection Example
- 07 Protection System and Troubleshooting
- 08 Warranty

TECHNICAL SPECIFICATION

- Operation topology: Full range class D
- 12db/octave variable active Linkwitz-Riley crossover: 18Hz - 8kHz
- Input impedance: 47k ohms
- Frequency response: 18Hz - 8kHz (-3dB)
- Variable subsonic filter: 18Hz - 120Hz
- Fuse: MIDIVAL 60A (x 6) + GLASS 0.5A
- Clip indicator
- THD < 0.3%
- SNR > 82.4dB
- Damping factor > 100
- Input sensitivity: 200mV - 1V
- Differential input signal
- Cooling fans
- Dimensions: 29.6"L x 2.5"H x 10.1"W
- Weight: 29.8lb

These values are typical and may present some minor variation.

TECHNICAL SPECIFICATION

Output:

- 1 channel 10.000Wrms 1ohm - 12.6Vdc
- 1 channel 6.000Wrms 2ohms - 12.6Vdc

Current draw at full power(average music program): 476A*

*Equivalent to current draw with resistive load and sinusoidal signal at half power.

Front panel view

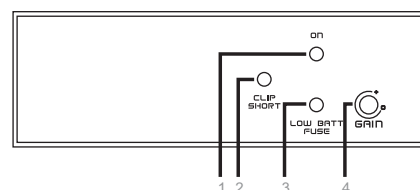

1. Blue LED: • On
2. Red LED: • Blinking - Output distorted (Clip) / Constant - Output short circuit
3. Yellow LED: • Blinking - Low voltage battery / Constant - Fuse blown or missing
4. Gain Control

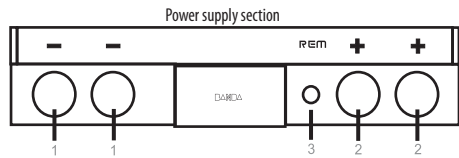

1. Negative power input (ground): connect to car chassis.
2. Protection fuse: .
3. Remote input: connect to radio/cd remote output.
4. Positive power input (+12Vdc): connect to battery positive terminal.

Signal input and power output section.

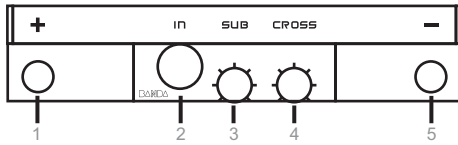

1. Positive speaker output
2. Signal input (RCA)
3. Subsonic control
4. Crossover control
5. Negative speaker output

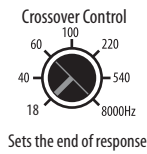
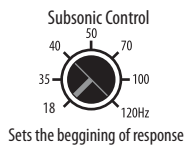

CLIP INDICATOR

The red LED lights up when the amplifier output is distorting. As long as the speakers used are capable of handle the total output power this LED can eventually blink but if it holds still it means too much distortion in the output and this can damage the speakers and the amplifier. In this case, turn down the head unit volume.

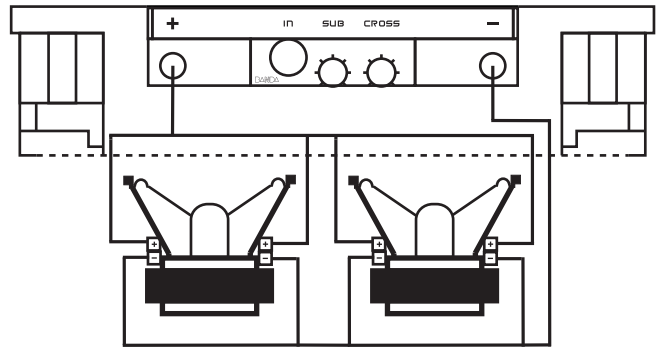

4+4ohms 5000Wrms subwoofer x 2 wired in parallel

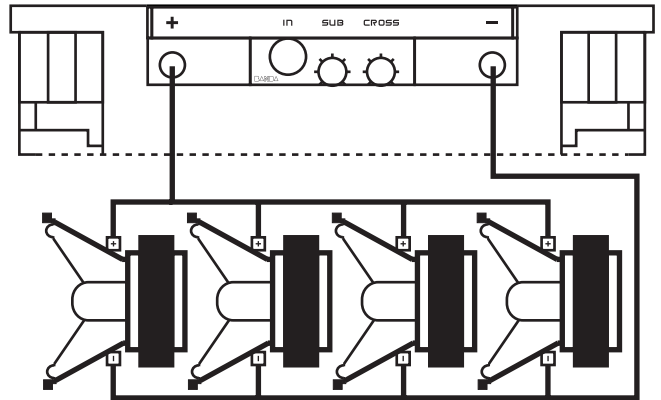

4ohms 2500Wrms woofer x 4 wired in parallel

NOTE: These are basic projects, just given as examples.

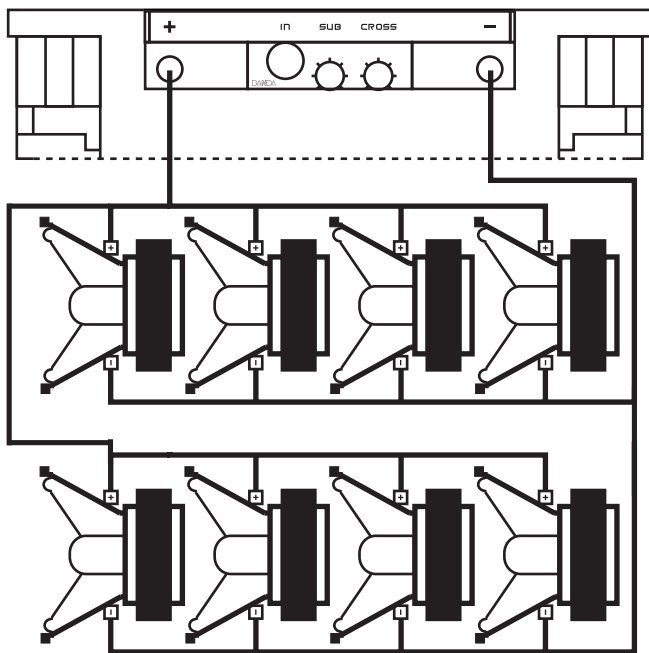

8 ohms 1250Wrms woofer x 8 wired in parallel

NOTE: These are basic projects, just given as examples.

Short Circuit protection:

If short circuit is detected in output terminals, the amplifier shuts down and the red LED lights up. The equipment must be turned off, solve the short circuit problem and turn the equipment on again. If the problem is solved, the blue LED must light up. If the load impedance is lower than the amplifier specification, the equipment may trigger the short circuit protection.

Low Voltage Protection:

When battery voltage is lower than 9Vdc, the amplifier will shut down and the yellow LED will blink until the equipment is restarted.

Power Supply Inverted Cable Protection:

If the power supply cables are connected inverted, the internal fuse will blow.

Troubleshooting:

Protection triggered

1. Check if the internal fuse is blown. If so, replace it with a same current rate fuse (60A x 6)
2. Check if there is short circuit in the output terminals. To do it, turn off the amplifier, disconnect all speakers and the input RCA cable and wait about 20 seconds. Turn the amplifier again and if the blue LED lights up, the amplifier is operating normally.
3. Check if any speaker is presenting short circuit or the total impedance load is lower than the amplifier specification.
4. Check if there is enough current in battery to supply the amplifier and if the cables are capable of conduct that current.

Output Noise

1. Check if there is loose connection in signal input or in the RCA cable.
2. Check if there is ground connection in the radio/cd RCA output.
3. Check if RCA cables are wired separated from the power cables.
4. Check if the +12Vdc that powers the amplifier is coming directly from the battery.
5. Check if ground cable is connected in car chassis as near as possible of the amplifier.
6. Both radio/cd and amplifier must be firmly connected to car chassis ground to avoid noises and voltage fluctuations at amplifier output.

Important Notes:

- Use 2 AWG power cables for both GND and +12Vdc.
- Do not use impedance load lower than the amplifier specification. This can damage the equipment.
- Use wire solder for tinning the cable end for better electrical contact. Loose electrical connection can cause malfunction, heating and even fire
- The GND connection must be as short as possible, using adequate wire terminal firmly connected to a clean, paint free spot at the car chassis.
- If more than one amplifier is used, provide adequate individual wiring for each one.